

MANUAL 2Park Up frame

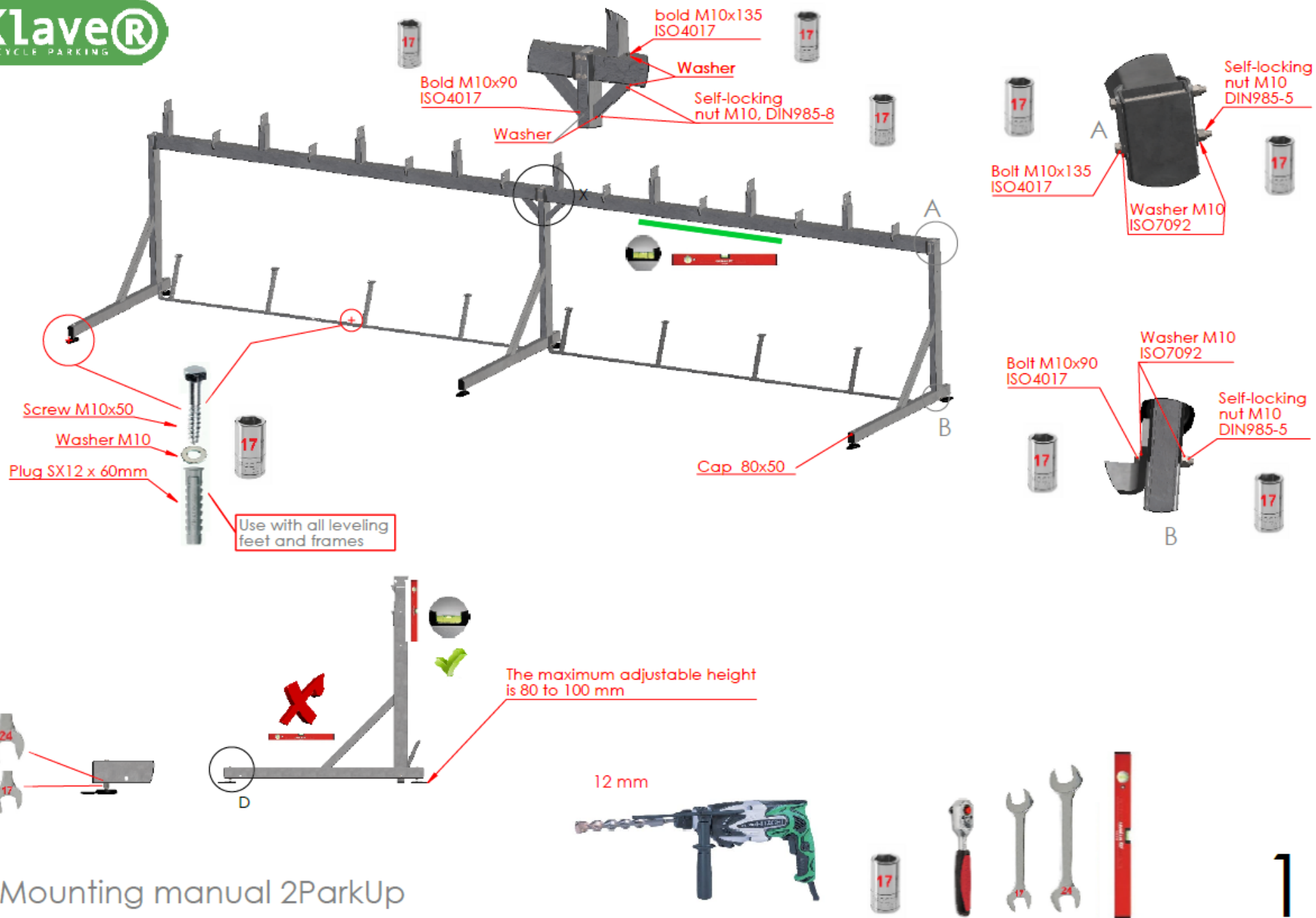

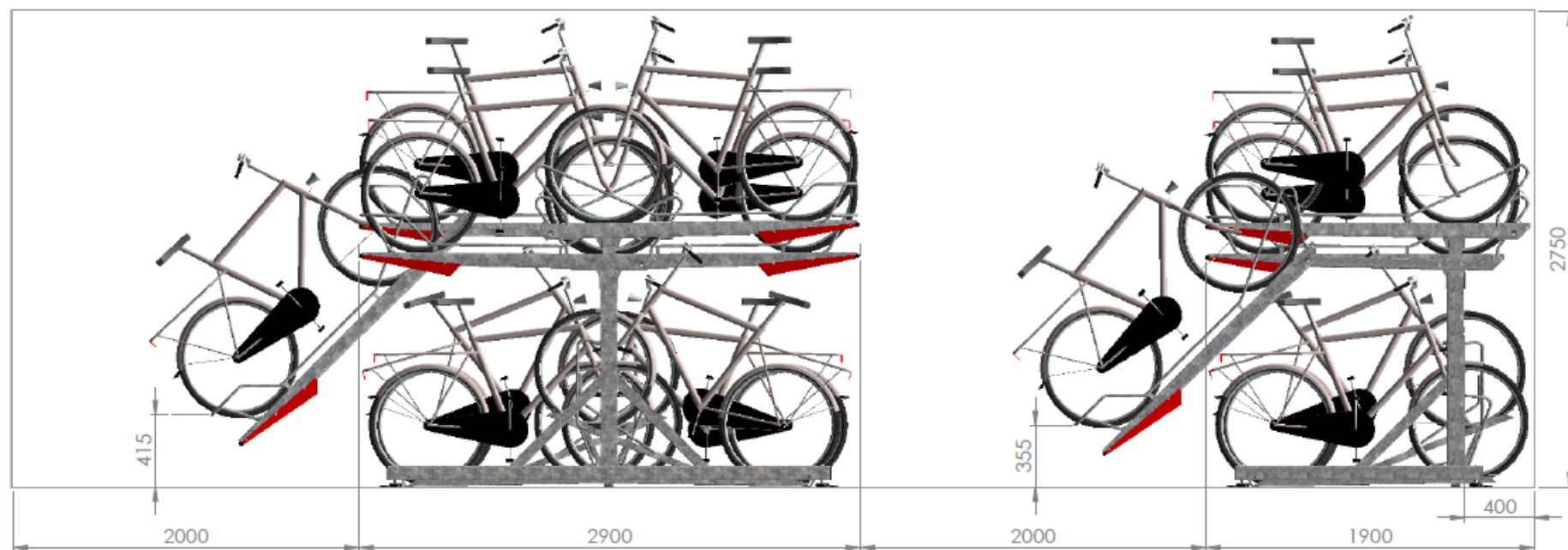

2ParkUp AWB Side view

(maten in mm)

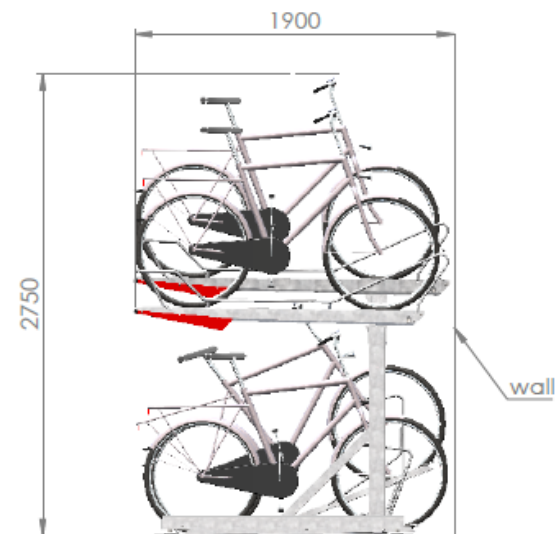
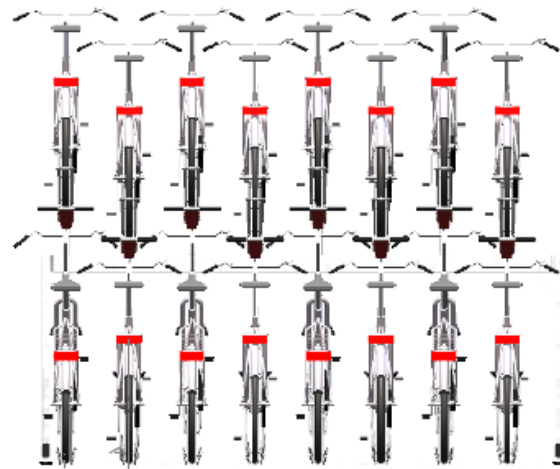
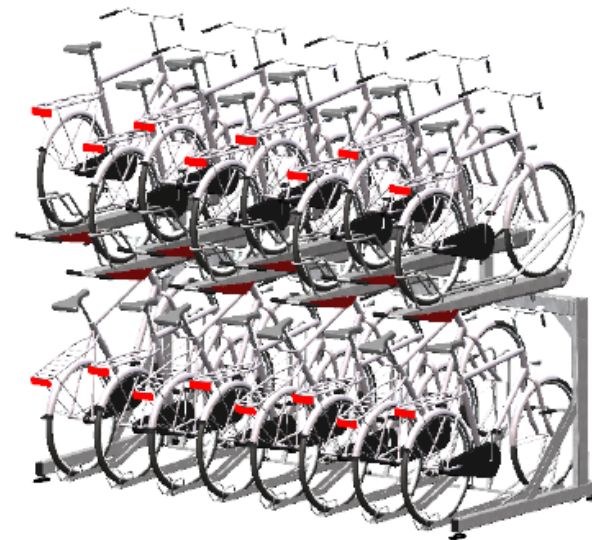
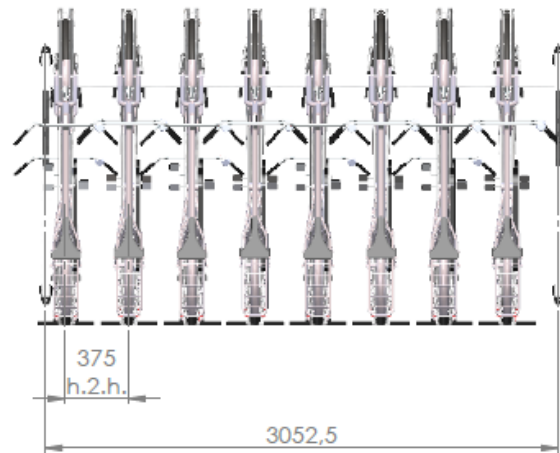

2ParkUp AWB, h.2.h. 375 16 bp single-sided

(measurements in mm)

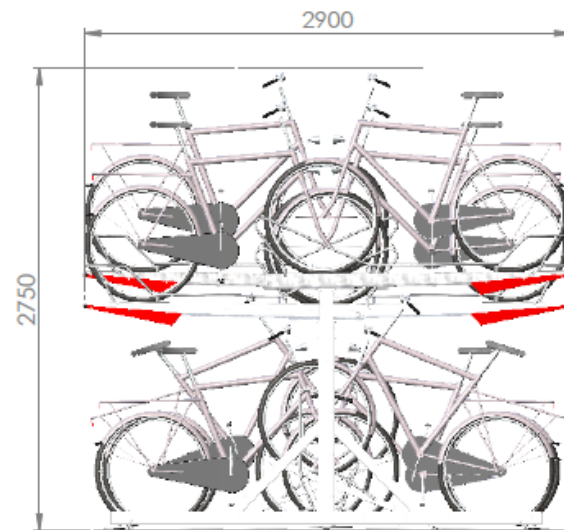
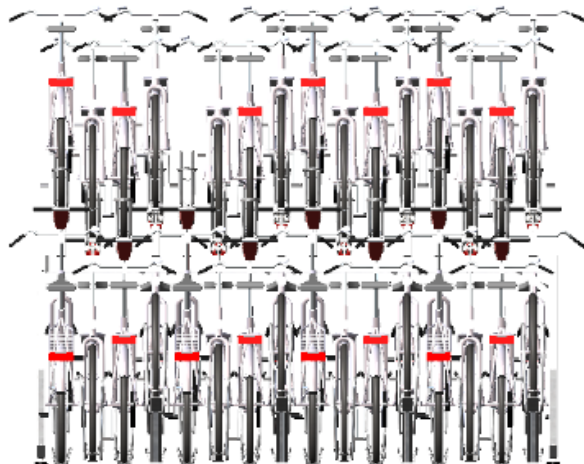
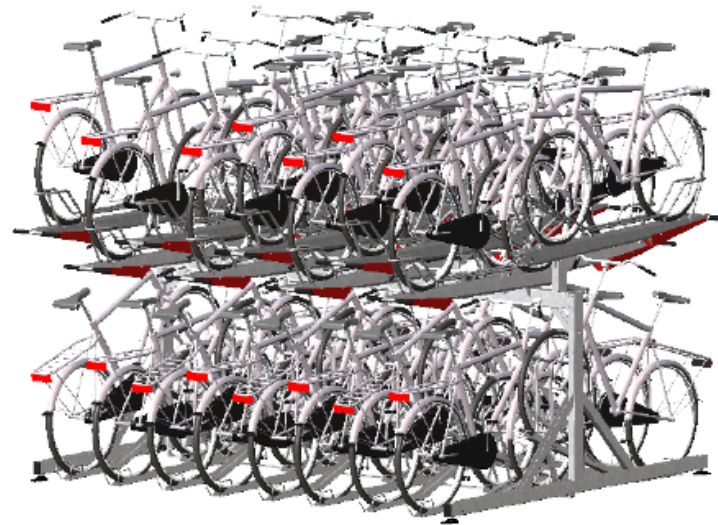
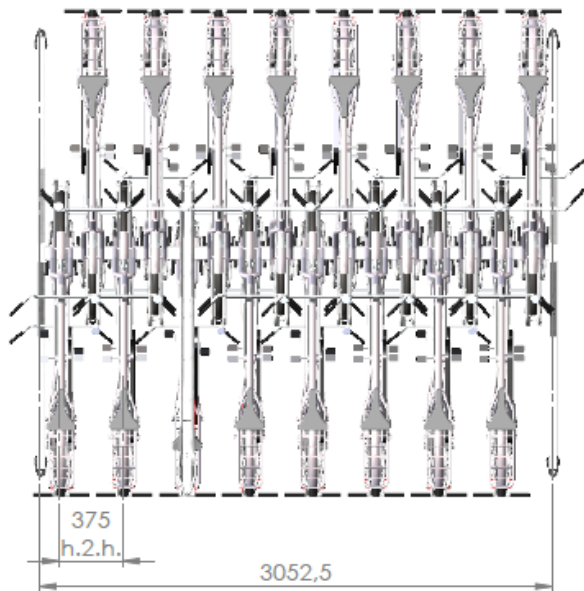

2ParkUp AWB, h.2.h. 375 32 bp double-sided

(measurements in mm)

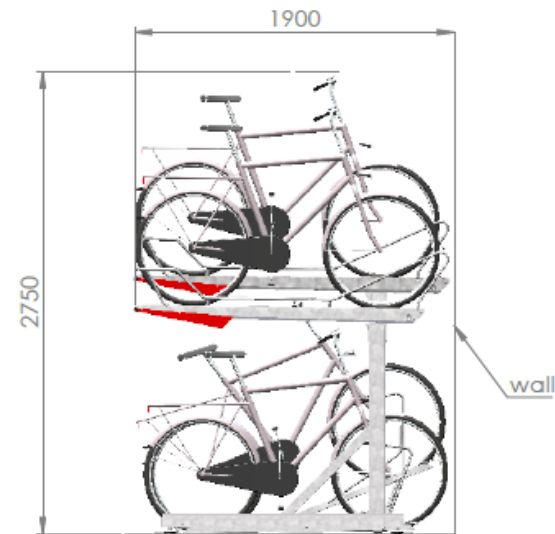
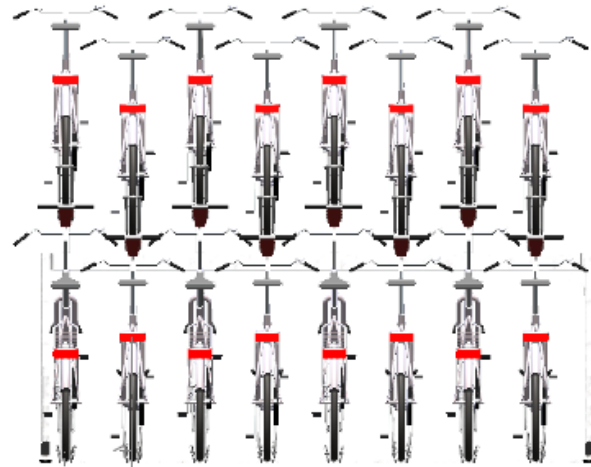
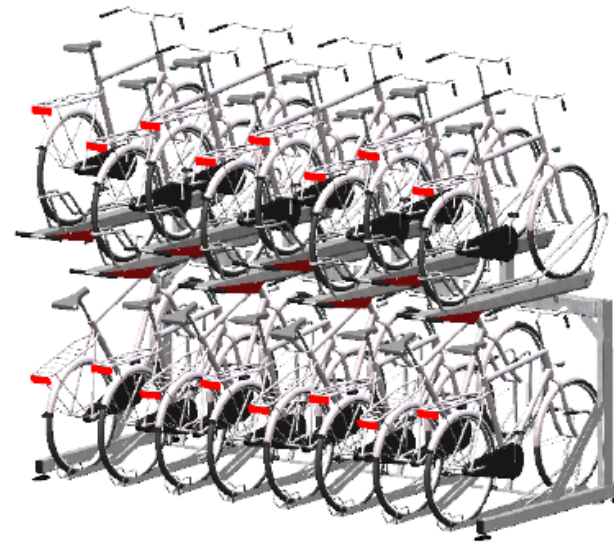
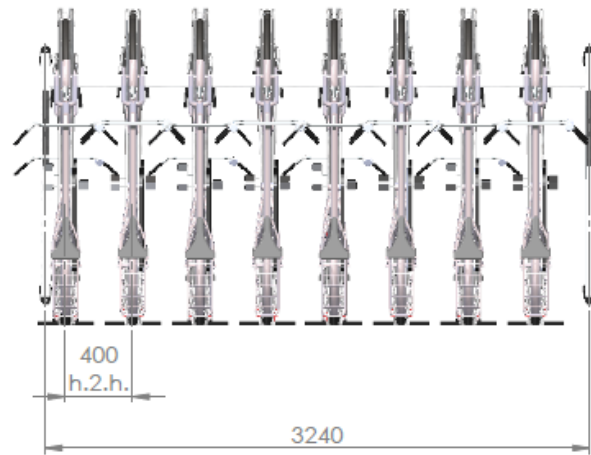

2ParkUp AWB, h.2.h. 400 16 bp single-sided

(measurements in mm)

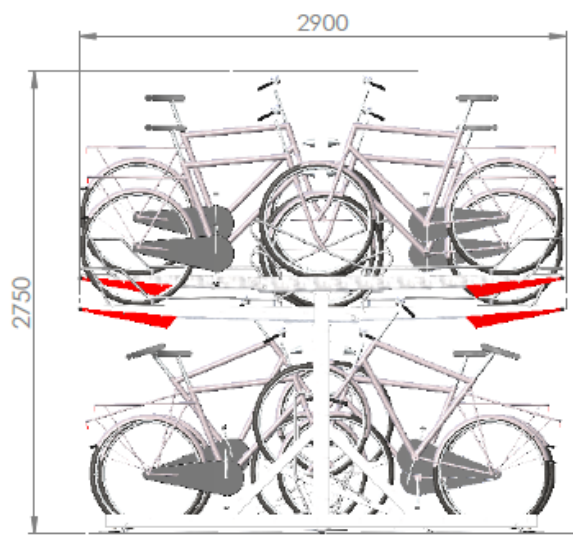
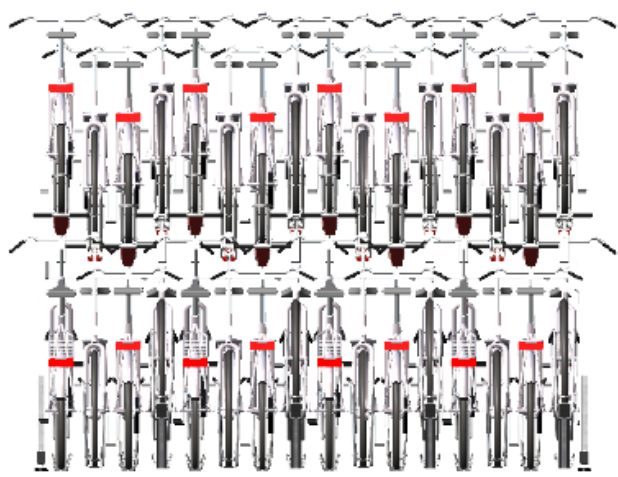
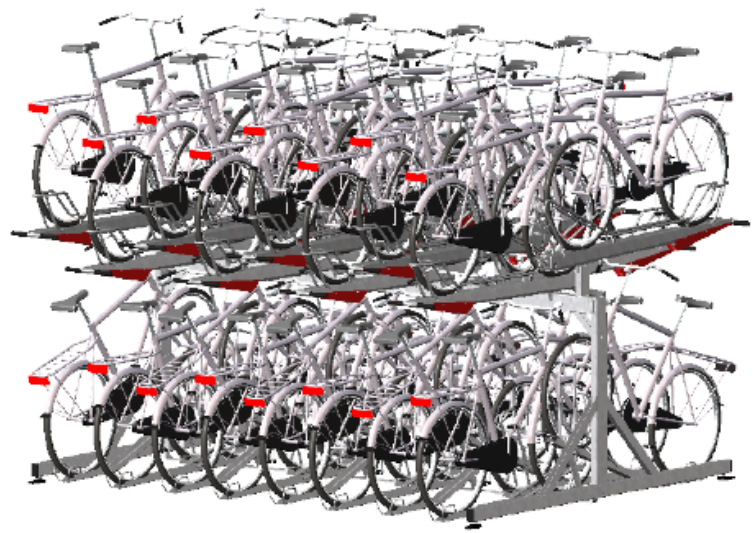
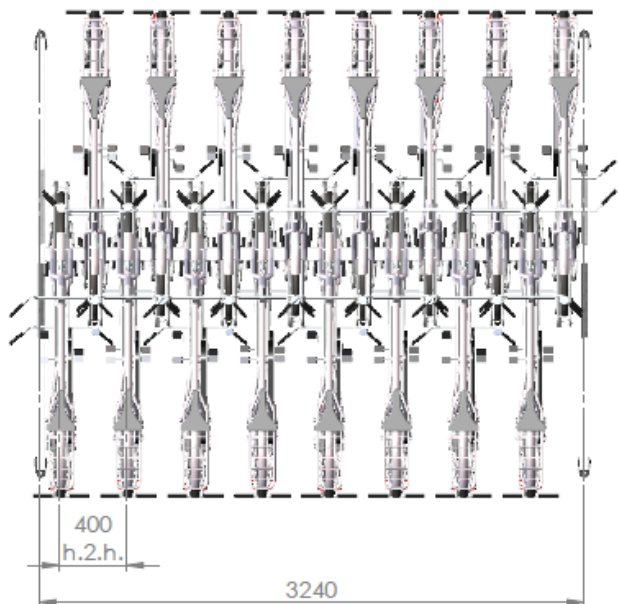

2ParkUp AWB, h.2.h. 400 32 bp double-sided

(measurements in mm)

Manual per bicycle place high & low

Bolt M10x30
Washer

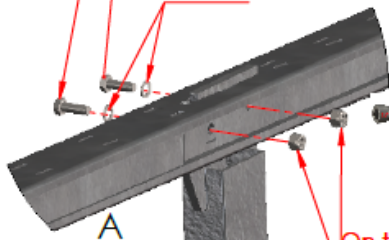

A

On this side only
M10 lock nut

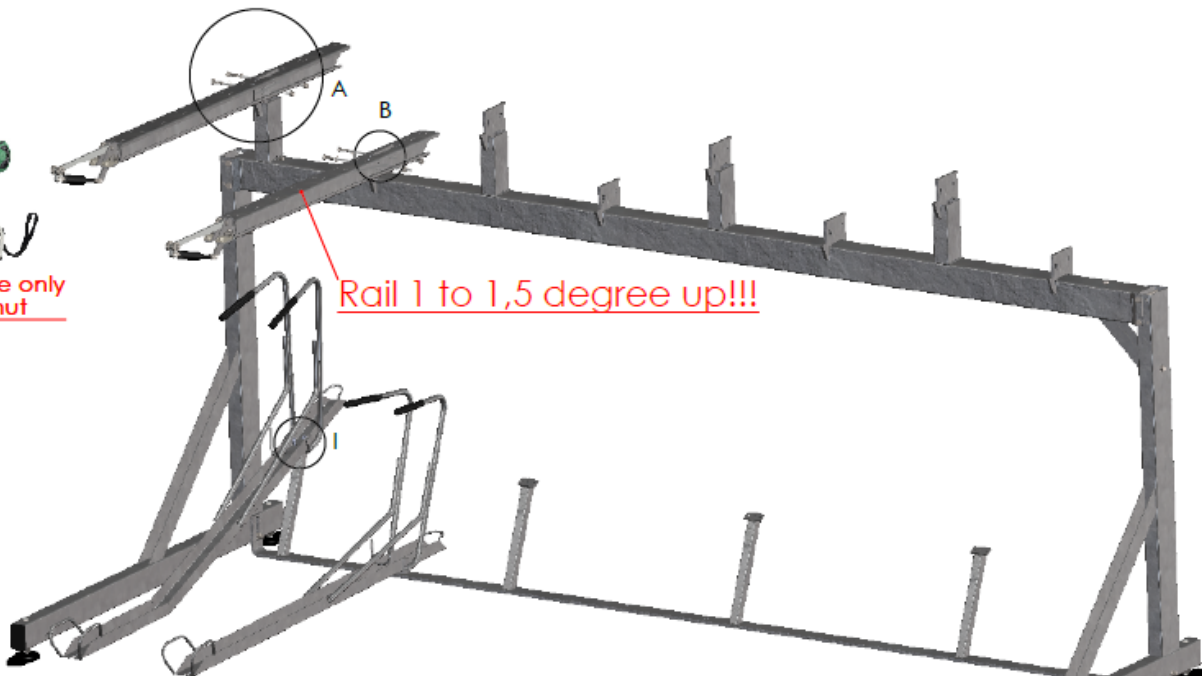

Rail 1 to 1,5 degree up!!!

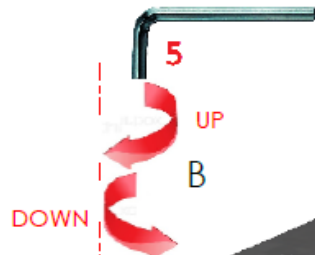

5

UP

DOWN

B

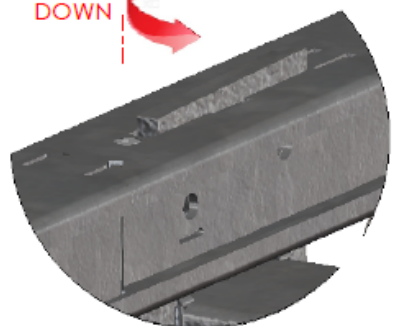

PZ.4



2x Bolt DIN7500
CM8x20
for each gutter

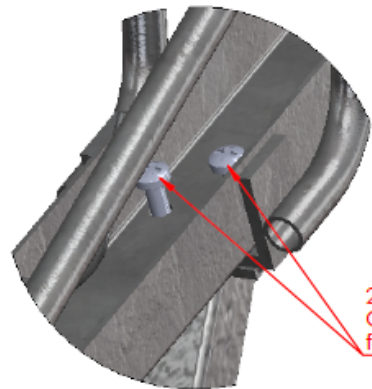

1

